









Installation RecessFix

! Do not damage the product when using a sharp knife to open the packaging! Fitting screws: Use a size-2 screwdriver (Pozidrive) or use an electric screwdriver at it's lowest torque. Rail removal: Use a flat screwdriver of max. 6 mm wide. Only use the original screws enclosed, to prevent malfunctioning from using too thick screw heads!



Installation Option

s8

Height in mm	Number of parts							
								
- 1020	2	2	2	4	4	2	4	2
1021 - 1720	2	2	2	6	6	2	4	2
1721 - 2420	2	2	2	8	8	2	4	2
2421 - 3120	2	2	2	10	10	2	4	2
3121 - 3820	2	2	2	12	12	2	4	2
3821 - 4000	2	2	2	14	14	2	4	2

20/25 mm

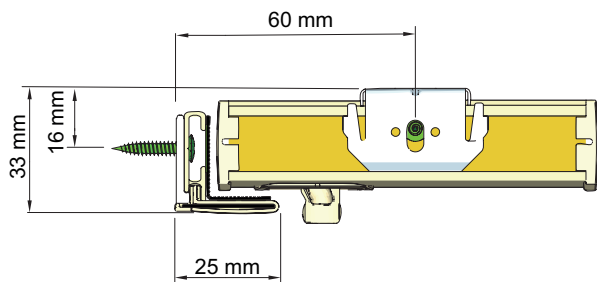

32 mm

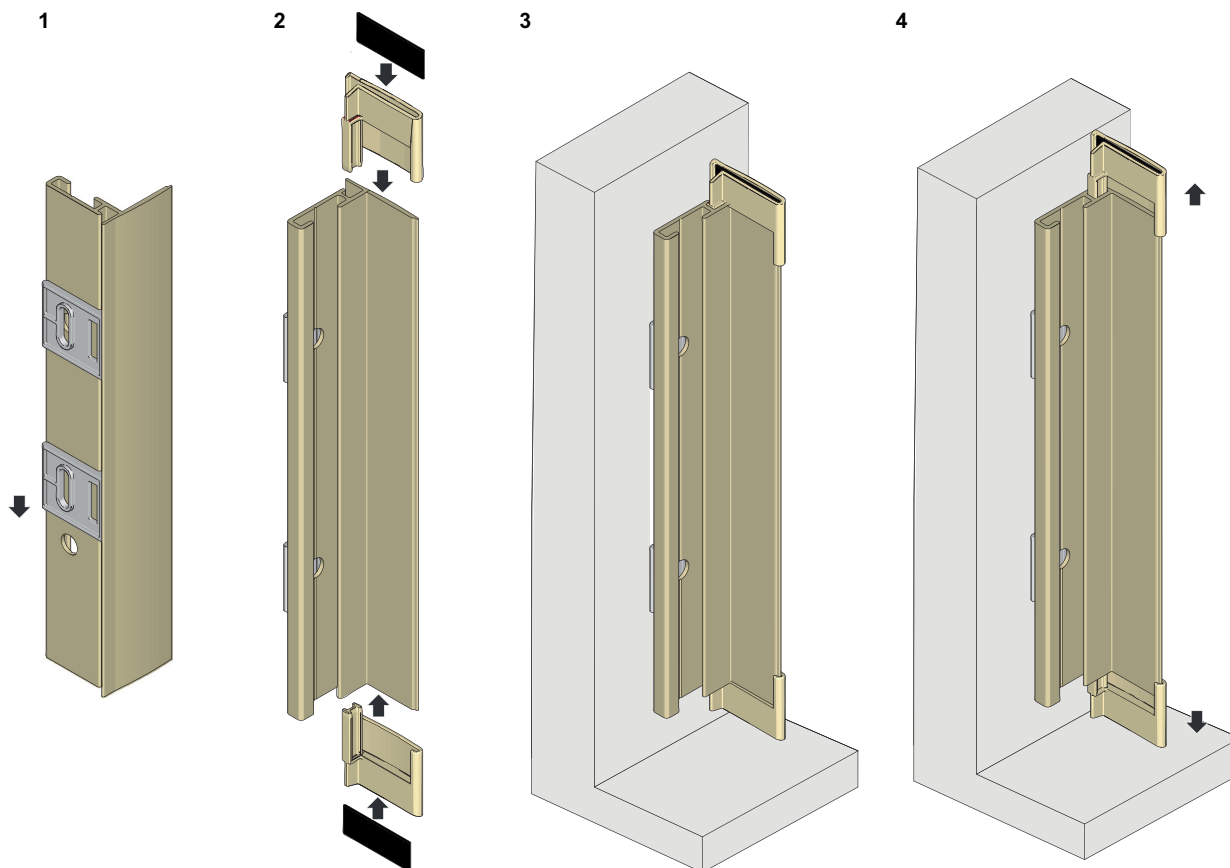
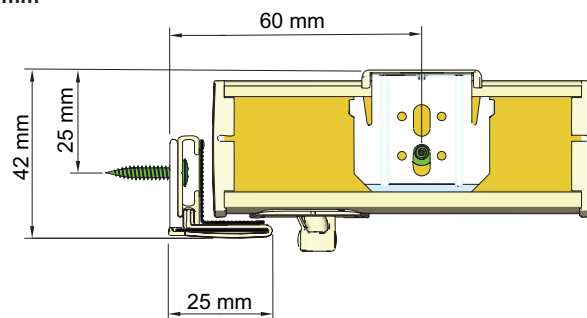

5

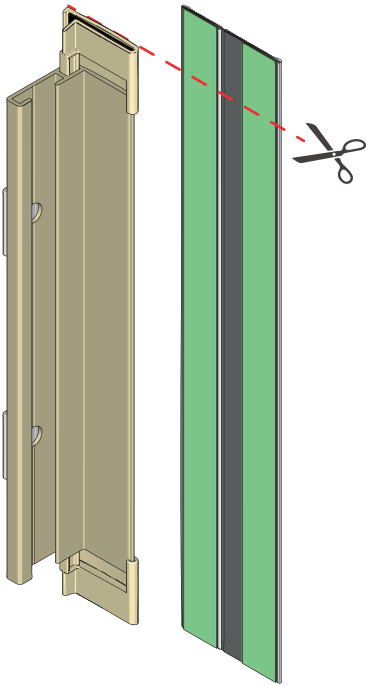

6

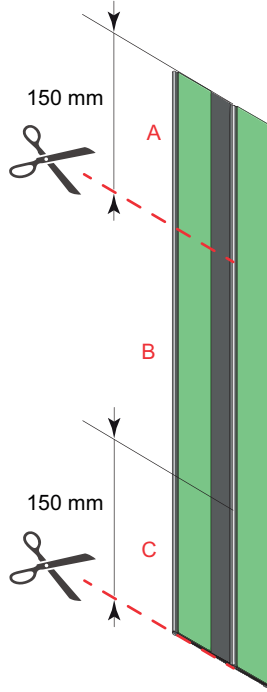

7

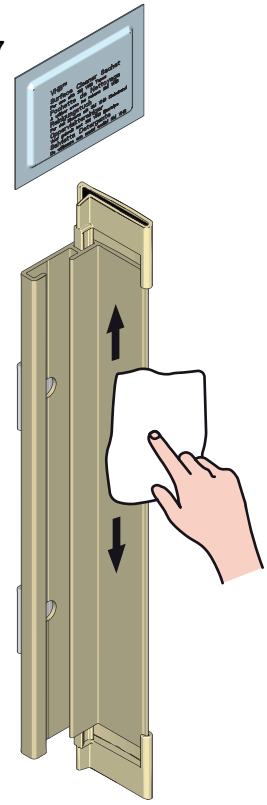

8

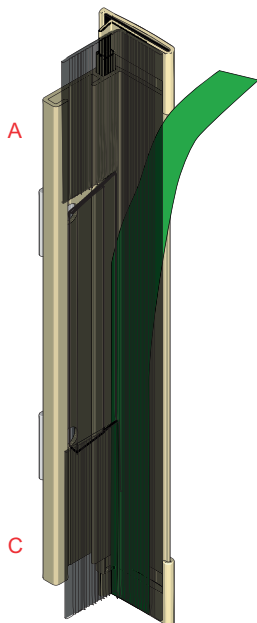

9

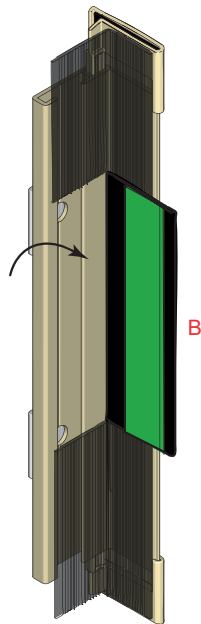

10

